

Before you start



CAUTION



Many new and factory radios require a reset code when disconnected from battery power. This is an anti-theft feature. Before unplugging power, you must determine if your radio/source unit requires a reset code. Check the operation manual for your vehicle or contact the dealer.

Power cable size and fusing

It is critical to use the proper power and ground cable. Select the size listed here for your amplifier model. Always use high quality copper cable. Visit our website for multi amp system cable recommendations.

Be sure to use the proper fuse size for each model. Some models require an external fuse.

Model	Fuse Size	Cable Size
BE35-500.4	2x25A ATC	4ga
BE35 800.4	2x35A ATC	4ga
BE35 1200.1D	1 x 80A Maxi	4ga
BE35 1700.1D	2 x 70A Maxi	2ga
BE35 2100.1D	External 200A	0ga
BE35 2500.1D	External 250A	0ga
BE35 5000.5	External 100A	2ga

Installation

1 Disconnect negative battery terminal

Place terminal in a secure position so that it won't accidentally contact the negative battery post

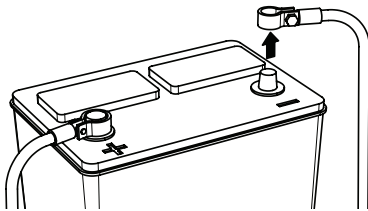

2 Run Cables

Properly route power, speaker and RCA cables through the vehicle.

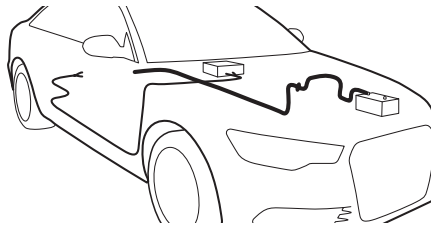

3 Mount Amplifier

Choose a mounting location that will provide adequate air ventilation. Mount the amplifier to a secure surface. Do not mount the amplifier upside down.

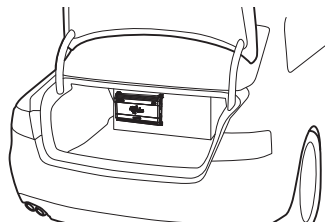

4 Chassis Ground



The chassis ground connection is critical to the performance of the amplifier. Choose a location that is close to the amplifier. Completely scrape away the paint and use a nut and bolt if possible. **DO NOT USE AN EXISTING FACTORY BOLT!**

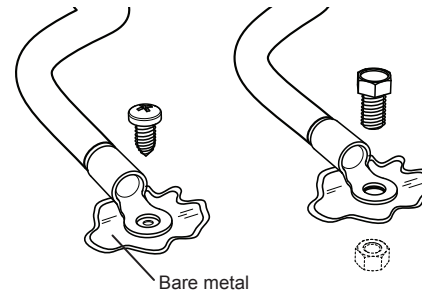

Bare metal

5 Negative Power Connection

Attach the chassis ground cable to the amplifier negative terminal. It is important to make sure this connection is very tight.

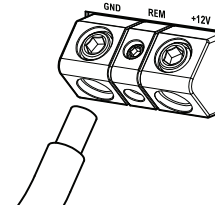

6 Remote Turn-on Connection

Attach the remote turn on wire to the amplifier remote output of the source unit.

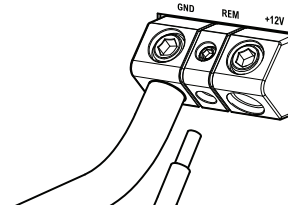

7 Positive Power Connection

Attach the main power cable to the amplifier +12V. The cable must run directly to the battery and be properly fused and be very tight.

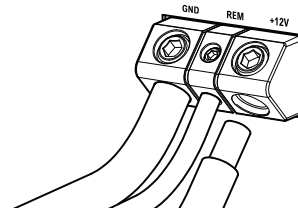

8 Signal Input Connection

Connect the RCA cables to the INPUT connectors. The OUTPUT can be used to provide input for a second amplifier.

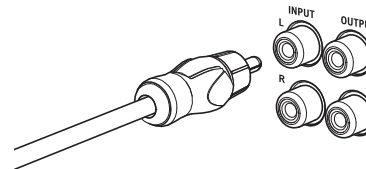

9 Level Control

Turn the LEVEL control completely counter-clockwise to minimum.



10 Speaker Connections

Connect the speaker cables to the speaker output connectors. Follow the diagram below that best fits your speaker configuration.

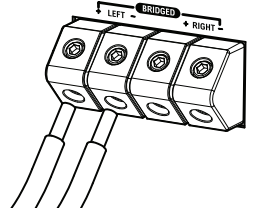

Stereo

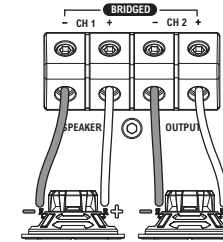

Bridged

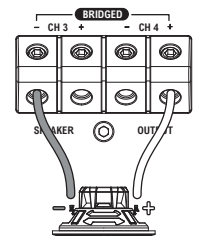

Monoblock single woofer

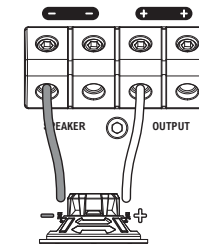

Monoblock multiple woofers

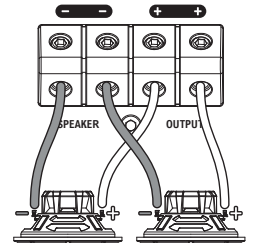

11 Positive Battery Connection

Connect the power cable to the positive battery terminal. The power cable must be fused within 18 inches of the battery terminal.

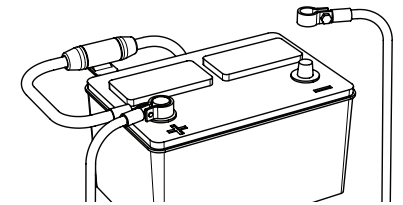

Be prepared to disarm your vehicle's alarm and to enter your radio / source unit code.

12 Re-connect Negative Battery Terminal

Re-connect the negative battery terminal making sure it is securely tightened.

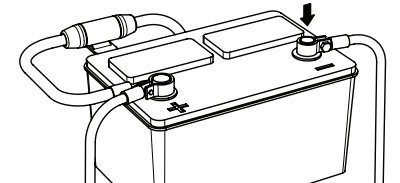

Setup

A **Input Mode**

The MODE switch will sum or combine the right and left channel signals in the 2CH position to improve bass performance when bridging the amplifier to mono. Use the 4CH mode when driving four full range speakers.

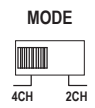

B **Xover Mode**

The XOVER Mode switch sets the type of crossover that will be active. 4 channel models will have two switches, one for each set of channels.

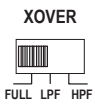

C **High pass Adjustment**

The HPF (high pass filter) control will limit the output below the selected frequency. This is typically used to protect midrange and hi frequency speakers from damage and to allow a smooth transition from a subwoofer.

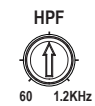

D **Low pass Adjustment**

The LPF (low pass filter) control will limit output above the selected frequency. This is used to allow a smooth transition to the higher frequency speakers.

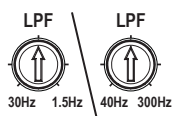

E **Bass Boost**

The Bass EQ control will increase the power output at 45Hz for more pronounced bass. Exercise caution when using this control. Increase the level in small amounts until distortion is noticed, then back off a little.



F **Remote Level Control**

Some models include a bass remote. Avoid adjusting the bass remote while operating vehicle.

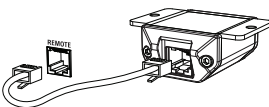

G **Level Setting**

This is a critical step to insure your amplifier is properly adjusted to match the signal output level of your source unit.

THIS IS NOT A VOLUME CONTROL!



1. If possible, with the source unit off, confirm that the primary volume control is turned down (counter clockwise).
2. Turn on the source unit (CD, or MP3 player). Re-confirm that the volume is turned down. Make sure the source unit controls; balance, fader, bass and treble are all set to center or "0" adjustment. Make sure that the green LED on the end of the amplifier is illuminated.
3. Play a clean musical selection of which you are very familiar. CD is preferred. Do not use radio signals for level setting. Hit play and start turning the volume of the source unit up.
4. Stop increasing the source unit volume when you reach 3/4 (about 75%) or until you hear speakers begin to slightly start producing distortion.
5. Increase the amplifier level (clockwise) until distortion is heard, then back the level down (counter clockwise) until the distortion is eliminated. Small adjustments may need to be made to balance the levels of multiple amplifiers.

Common System Setup

4ch - Full Range

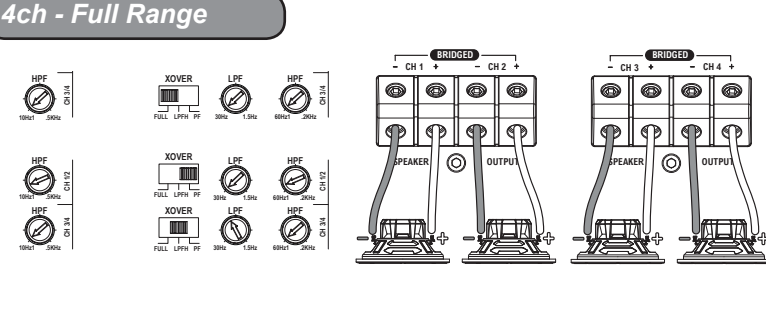

4ch - Mixed Mono

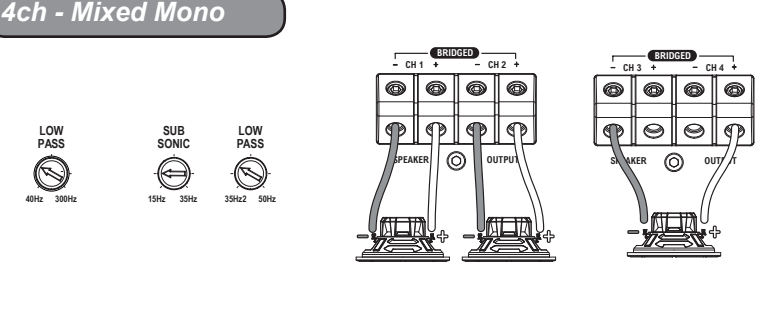

Mono

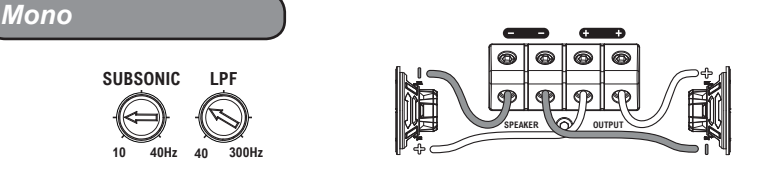

The information contained within this document is intended to offer some basic guidelines for a few of the most common installations. More complex audio systems should be installed by a competent professional. Additional installation information available at www.maxxsonics.com

WARRANTY

Maxxsonics USA Inc. warrants this product, to the original consumer purchaser, to be free from defects in material and workmanship for a period of one (1) year from the date of purchase. Maxxsonics USA Inc. will, at its discretion, repair or replace defective products during the warranty period. Components that prove to be defective in materials and workmanship under proper installation and use must be returned to the original authorized Maxxsonics USA Inc. retailer from where it was purchased. A photocopy of the original receipt must accompany the product being returned. The costs associated with removal, re-installation and freight are not the responsibility of Maxxsonics USA Inc. This warranty is limited to defective parts and specifically excludes any incidental or consequential damages connected therewith. To view the full warranty, please visit the website.

Hifonics products are designed and engineered in the USA by

MAXXSONICS®

847-540-7700

www.maxxsonics.com

HF BE35 2015 QSG 01 - rev1

HIFONICS

Quick Start Installation Guide

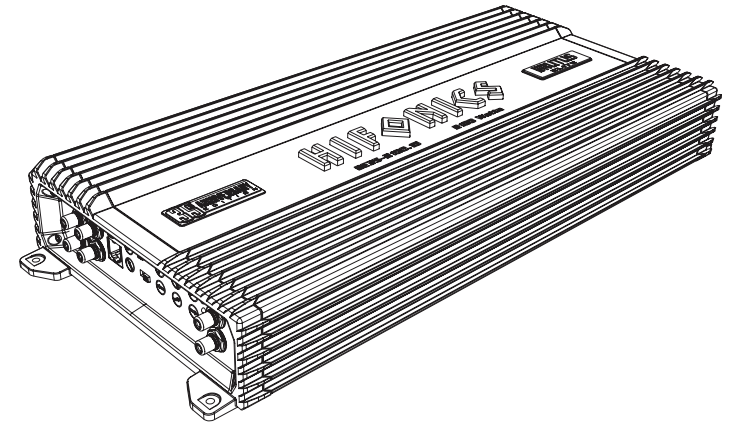

BE35 500.4 BE35 2100.10
 BE35 800.4 BE35 2500.10
 BE35 1200.10 BE35 5000.5
 BE35 1700.10

35TH ANNIVERSARY
 EDITION

Congratulations on your choice of a Hifonics amplifier. This "Quick Start Installation" guide is meant to help you "hook up" and play music. For more detailed information, on system setting, speaker and subwoofer configuration and full specifications by model visit the website, <http://hifonics.com/manuals.html>